

User Manual

Outdoor 43-Inch Mobile LCD Signage

Model: DGYAFOD43

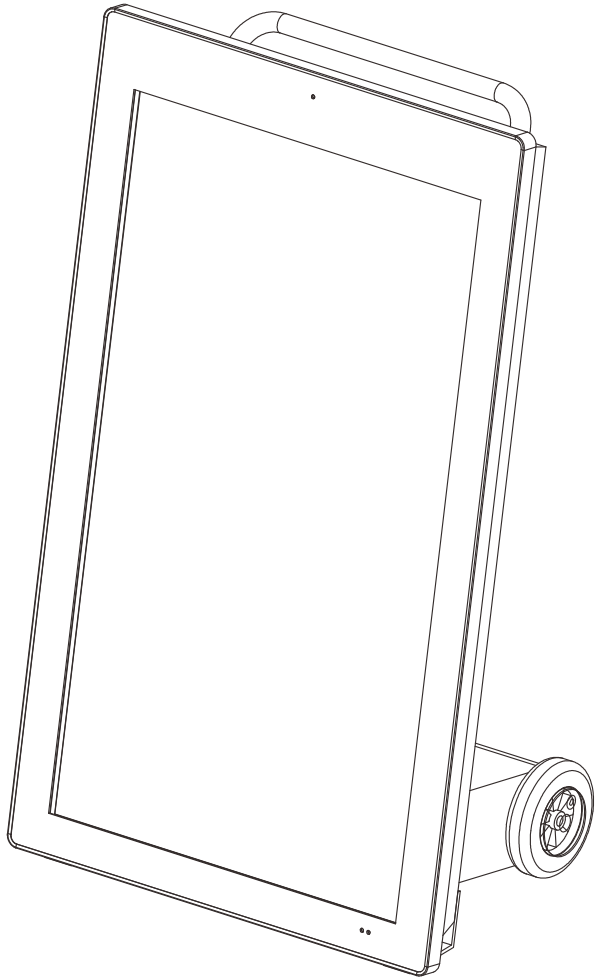

CONTENTS

1. Product Information

1.1 Product Features -----	1
1.2 Product Composition -----	1
1.3 Parts List -----	3
1.4 Technical Specifications -----	6
1.5 Safety Warnings and Precautions -----	7

2. Operation

2.1 Power On/Off -----	10
2.2 Remote Control -----	10

3. Playback and Update

3.1. Program Playback -----	11
3.2. Content Update -----	11

4. OSD Menu

4.1. Publishing Mode -----	13
4.2. System -----	16
4.3. Feature Settings -----	29
4.4. About Terminal -----	35

5. System Upgrade

System Upgrade -----	37
----------------------	----

6. Product Warranty and Maintenance

6.1 Warranty Policy -----	38
6.2 Maintenance Guidelines -----	38

1. Product Information

1.1 Product Feature

The battery-powered, 43-inch waterproof LCD is a floor-standing LCD signage product featuring an elegant frame design and a high-quality LCD screen. It is equipped with a Signway control board and an embedded UL/CE-certified power supply. This versatile device supports wireless, Ethernet, cloud platform, and USB program editing and playback, making it suitable for advertising, education, commercial, and other communication purposes in any desired location.

The integrated light sensor adjusts screen brightness according to ambient lighting (ranging from a minimum of 30% to a maximum of 100%, with 256 levels of intelligent recognition and dimming). This feature helps conserve energy and extends the lifespan of the device.



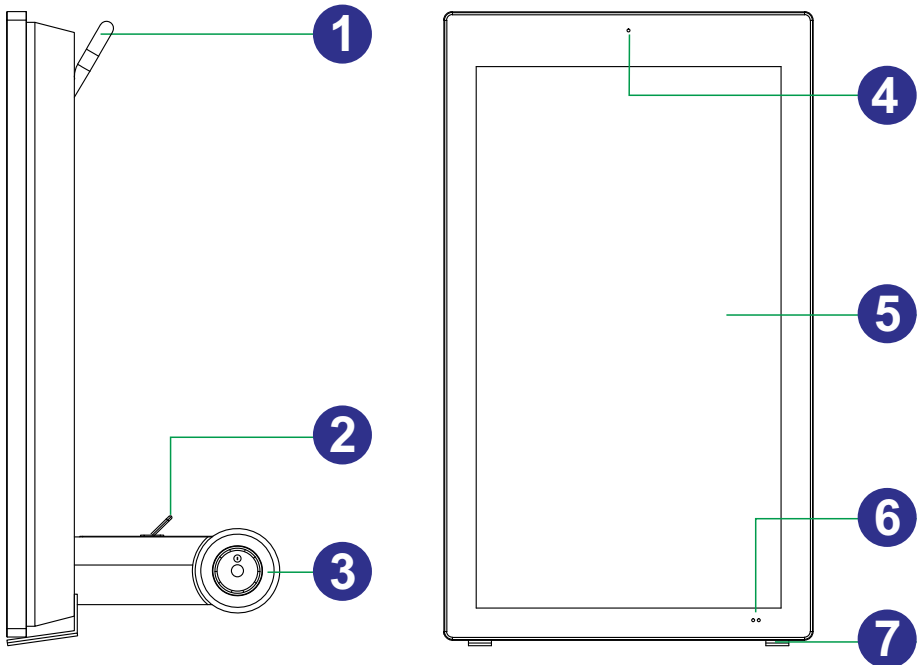

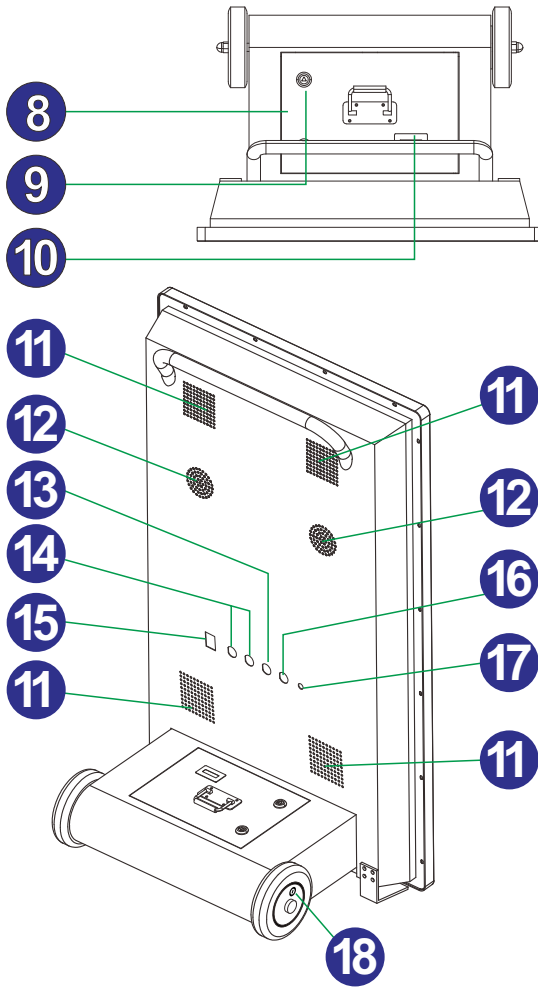
1.2 Product Composition



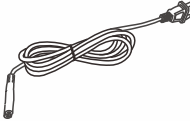
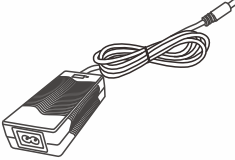
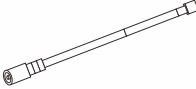

- | | | |
|--------------------------------|-----------------------------|---------------------------|
| 1 Handle | 7 Non-slip mat | 13 USB port |
| 2 Handle of battery box | 8 Battery box | 14 USB port |
| 3 Wheels | 9 Lock | 15 Power switch |
| 4 Light sensor | 10 Battery indicator | 16 RJ45 |
| 5 LCD Screen | 11 Heat sink | 17 AC power socket |
| 6 IR Indicator | 12 Speaker | 18 Lock |

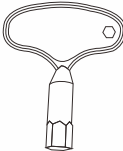
1.3 Parts List

Accessory	Photo	Qty	Remark
AC Power cord		1	with local plug
Power adapter		1	
Connection wire		1	
Remote control		1	
Key for wheels		2	
Key for battery case		2	
User menu		1	

- As shown in the photo, the area is the battery power indicator. If you need to check the power range, please press the (⏻) button, and the percentage of power will show on.
- When charging is required, plug the DC plug directly into the DC port to charge.

Note: when the battery power is too low and needs to be charged, we recommend that the battery power should not be less than 10% to ensure the life of the battery.

- **When the product needs to be stored for a long time, the battery power shall not be less than 30%.**

When the storage time is more than 1 month, it is recommended to charge the battery every month, and keep the power not be less than 30%, so as to keep long life of the battery.



Please be sure to charge with the 25.2V, 5A charger we provide!

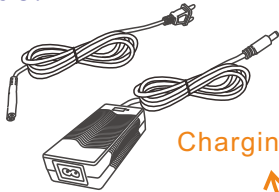

Charging port

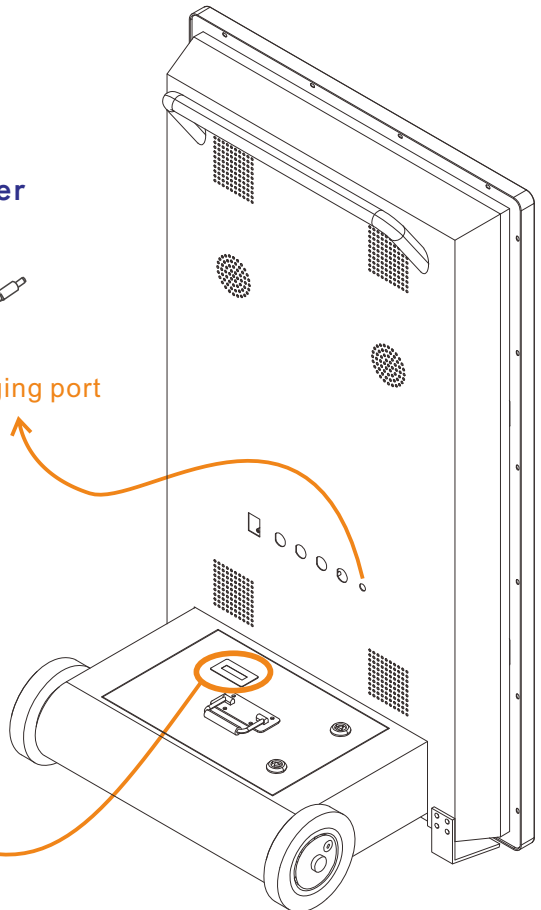

Please make sure to follow the below diagram to lock and unlock the battery box.

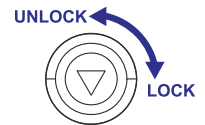
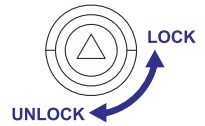
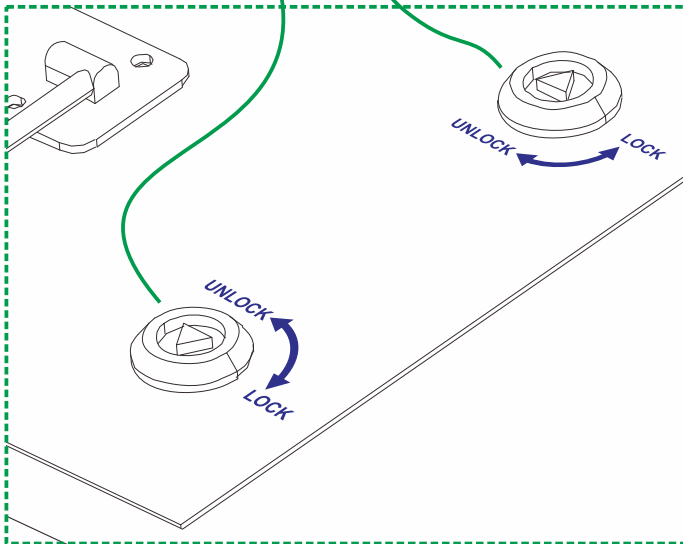
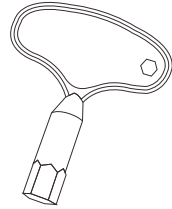
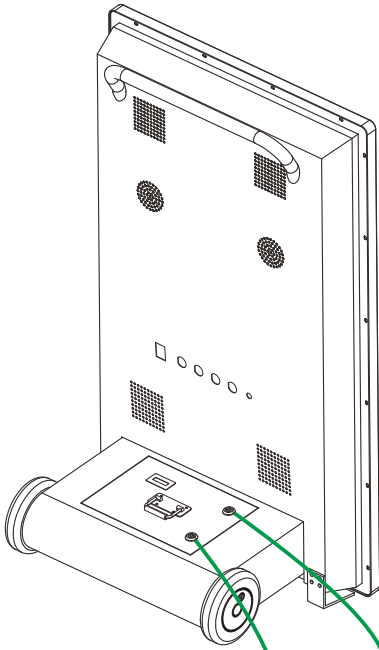

1.4 Technical Specifications

Item	Description
LCD size	43"
Light source	LED
Resolution	1920x1080
Brightness	1500nits (Typ.)
Contrast	1100:1
Response	8ms
Pixel pitch	163.35(H)xRGBx490.05(V)um
Refresh rate	60Hz
Viewing angle	89°/89°
Displays color	16.7M
Viewable area	940.896x529.254mm
Charging Adapter	
Input Voltage	AC100-240V
Hertz	50/60Hz
Power Consumption	Max. 128W
Environment	
Operating temperature	-10-45°C
Storage temperature	-20-60°C
Operating humidity	10% RH to 80% RH
Storage humidity	0% RH to 90% RH
Maximum operating time	7x18Hrs
Functions	
Operating system	Android 11.0
Speakers/Watts	2x10W
Software (NovaStar, DiViEx, Other)	Signway
Processor	RK3568
RAM	4G
ROM	32G
Decoding resolution	1080P
Playback mode	loop
Touch support	Non-touch
Supported Video Files	AVI, MPEG4, WMV, MKV, FLV, MP4, MOV
Supported Photo Files	JPG, JPEG, BMP, PNG
Ports	
TF	N/A
Antenna(external,internal)	Internal
Ethernet LAN	YES, 1xRJ45
HDMI IN / HDMI OUT	N/A
VGA	N/A
Headset	N/A
USB	2xUSB2.0 ,1*USB3.0
SIM	N/A
Structure	
Net Weight	About 50kgs
knockdown/fully assembled	Fully assembled
Gross weight	About 60kgs
Unit Dimensions (Width x Depth x Height)	1094(H)x643(W)x436(T)mm
Package Dimension (Width x Depth x Height)	1260(L)x595(W)x805(H)mm
Package Type(carton,case,honeycomb,crate)	Honeycomb carton
Shell Material	Steel+aluminum
Shell Color	Black
Other	
Cord Length	1.5M
Compliance Listed (on power source:UL)	Chaging adapter FCC& DOE VI
Battery Specifications	
Commodity Description	Li-ion battery 22.2V45Ah 999Wh
Watt Hours or Amps x Voltz	999Wh
Lithium per Battery (in grams)	About 84g
Number of batteries in unit	1
Quantity of lithium button cells per unit	108cells per battery
UN Number	UN3481
Hazmat Name	Class or DIV.: 9
General	
Application	Outdoor

1.5 Safety Warnings and Precautions

Based on the product design and LCD properties, the following safety measures must be observed during the handling and use of the device:

- Avoid high temperatures and high humidity environments: The operating temperature range is 0~40°C, and the operating humidity range is 10%~90%.
- Suitable operating time: The device is rated to be used for no more than 18 hours a day.
- Use suitable voltage input: The device supports a voltage range of 100~240V. Excessive voltage can damage the device.
- Avoid exposure to strong electromagnetic environments: Strong electromagnetic waves can damage the device.
- Ensure proper ventilation: Operate the device in a well-ventilated environment for optimal performance.
- Avoid excessive vibration, heavy drops, and severe impacts: Such conditions can cause damage to the device.
- Do not replace or modify product parts yourself: Do not attempt to replace or modify components yourself. We will not be held responsible for any resulting problems.
- Perform regular cleaning: Routine cleaning helps maintain proper device operation.

Lithium Batteries Disclaimer of Liability

Guangzhou You Guang Optoelectronics Co., Ltd is not responsible for any direct, indirect, special, or consequential damages and personal injuries, including that to life, and health, resulting from the customer's application and use of Guangzhou You Guang products. You, the customer, assume full and unlimited responsibility for all customer Battery applications and uses. Your purchase of this product constitutes your agreement to hereafter assume full and total responsibility for your subsequent utilization of the Battery and you agree to defend, protect, save harmless, and indemnify Guangzhou You Guang., its officers, and employees relative to your potential use and misuse of this product. By purchasing or using a Guangzhou You Guang product you agree to the above terms.

IMPORTANT SAFETY INSTRUCTIONS AND WARNINGS

As Lithium batteries are volatile, please read these safety instructions and warnings before using or charging your batteries. Failure to do so may result in fire, personal injury, and damage to property.

General Guidelines and Warnings

- Battery charge and discharge rates are given as a multiplier of the capacity. For example, a 3300 mAh (mili Amp-hour) battery with a 20C rating, the maximum continuous discharge rate is:

$$20C \times 3300\text{mAh} \times \frac{1\text{Ah}}{1000 \text{mAh}} = 66\text{A}$$

- Store and charge in a fireproof container; never in your model!
- Never short a battery by cutting both wire leads simultaneously, contact with a conductive object, or any other means. If you accidentally short the wires, the battery must be placed in a safe area for observation as described above.
- In the event of damage (from a crash, etc), or swelling (ballooning); immediately cease use of the battery and observe it in a safe place for at least 30 minutes. Continuing to use a battery that has any physical damage, or has begun to swell may result in fire, injury, or damage.
- We recommend 3-5C max average discharge rate for breaking in new packs. Also be extremely careful not to over-discharge new packs (Packs should NEVER be over-discharged at any time, but over-discharging on the first flight will result in permanent damage to the battery).
- Never store or charge a battery pack inside a vehicle (especially in extreme temperatures).
- Store battery at room temperature between 40 and 80 °F (4 to 27 °C) for best results
- Do not expose battery pack to direct sunlight (heat) for extended periods.

Charging of Battery Packs

- Let Battery Pack cool down to ambient temperature before charging. Only charge batteries when the ambient, battery, and charger temperatures are between 32 and 113°F (0 to 45°C)
- Before connecting to charger, make a visual inspection of the pack. Look for any damaged leads, connectors, broken shrink, swelling of cells, or other irregularities. Do not use if you find any of the above issues with your pack.
- Do not charge batteries packs in series. Charge each battery pack individually. Failure to do so may result in incorrect battery recognition and charging functions.
- Use specific Balance Chargers only. Always check that all charger settings have been appropriately set for your specific battery pack.
- Always use balance charging. Do not charge without balancing; this will cause the cell voltages to become unbalanced; which may result in overcharging and damaging cells
- Never charge batteries unattended or overnight. When charging batteries you should always remain in constant observation to monitor the charging process and react to potential problems that may occur.
- Do not charge batteries above 25Volts/pack. Overcharged batteries are extremely dangerous.

Discharging (Use) of Battery Packs

- Do not discharge the batteries at a rate greater than they are rated for.
- Do not discharge batteries more than 80% of their capacity.
- Do not discharge batteries to below 3 volts per cell. Doing so will decrease the batteries lifespan.
- Discharge only when the battery and ambient temperatures are between 32 and 140°F (0 to 60°C).
- As a general guideline, a battery should never become so hot you cannot hold it tightly in your hand.

Battery Disposal

- Batteries that lose 20% of their capacity must be removed from service.
- Before recycling, discharge the battery to 3V/Cell, make sure output wires are insulated, and then wrap the battery in a bag.
- Do not dispose of batteries in the trash! Take your battery to an approved battery recycling facility.

2. Operation















2.1 Power On/Off

1. Flip the power switch to "ON."
2. Use the remote control to power on/off or press the power button on the device.
3. To shut down, flip the power switch to "OFF" and unplug the device.

Caution: Always disconnect the power plug before assembling or disassembling the unit.

2.2 Remote Control

For convenience, most operations can be done via the remote control. The functions of each button are as follows:

Button	Function
	Power switch
	Open the OSD menu settings
	Open signal source settings menu
	Pause/play program; Confirm selection
	Upward cursor
	Downward cursor
	Left cursor / Delete
	Right cursor
	Switch cursor / Adjust position in Android settings
	Return to previous menu / Press twice to exit media player
	Stop program playback and return to home screen
	Mute
	Increase volume
	Decrease volume



Note: The OSD menu can only be accessed by pressing the SETUP button on the media player home screen; If a program is playing, you must press the Pause button to exit playback mode before pressing SETUP to open the OSD menu.

3. Playback and Update

3.1. Program Playback

The player will start to playback programs automatically after powered on. If there is no content to be played, the home page will be displayed.

1. Make sure that the power cord and the storage card are correctly installed.
2. Turn on the player and the system will enter playback mode automatically.
3. The home page will be shown as below when there is no program for playback, or the earlier playback has been stopped.



The status bar above the main interface displays the current working status of the system, where the left side is the terminal working status, with two options: Stop and Downloading; On the right side is the playlist status, displaying Normal or error prompts such as screen mode mismatch, playlist invalid, etc.

The main interface displays three ways to publish programs and the operation steps. The operation details can be viewed by scanning the QR code.

The basic information of the terminal system is displayed below the main interface. These information include the local device code, software version, Android version, server address, local IP, and local storage. When in standalone release mode, it includes the local device code, software version, Android version, and local storage.

3.2. Content Update

In the case of terminal networking, users can create new programs on the server side and then publish them to the terminal. The terminal will automatically download various program update files every time it is turned on, and regularly check for updates during operation (in the background).

4.OSD Menu

1. Right click anywhere on the screen with the mouse, enter the password, open the OSD menu, and set the system parameters.



2. Click on Setup to enter the OSD main menu, which is divided into four modules: Publishing Mode, System, Function Settings, and About Terminal. Publishing Mode is displayed by default.

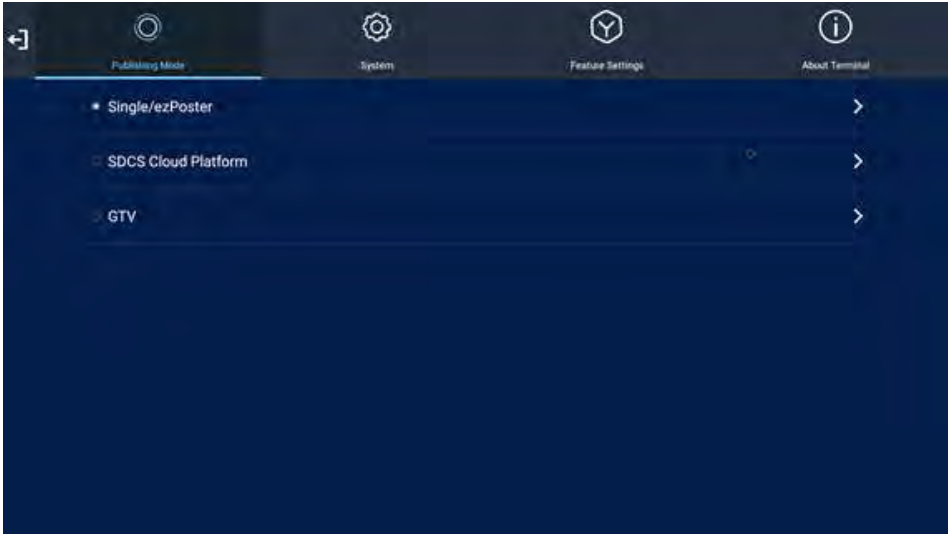

4.1. Publishing Mode

The terminal platform can work in standalone or networked situations.

The method of publishing programs is to scan the help QR code on the stop interface to watch the operation videos of three publishing modes. Select the publishing mode according to actual needs and press the back button to save the publishing mode.

4.1.1. Single/ezPoster

When the terminal is not connected to the internet and running alone, select this option.

- Programs can be imported through a USB flash drive, and the standalone template style and image playback duration can be selected according to actual needs;

- Alternatively, the program can be published through the ezPoster mobile app, and the NET ID on the mobile app and here must be consistent. Scan the "Scan and Download Apps" QR code on the stop interface to download and install ezPoster.

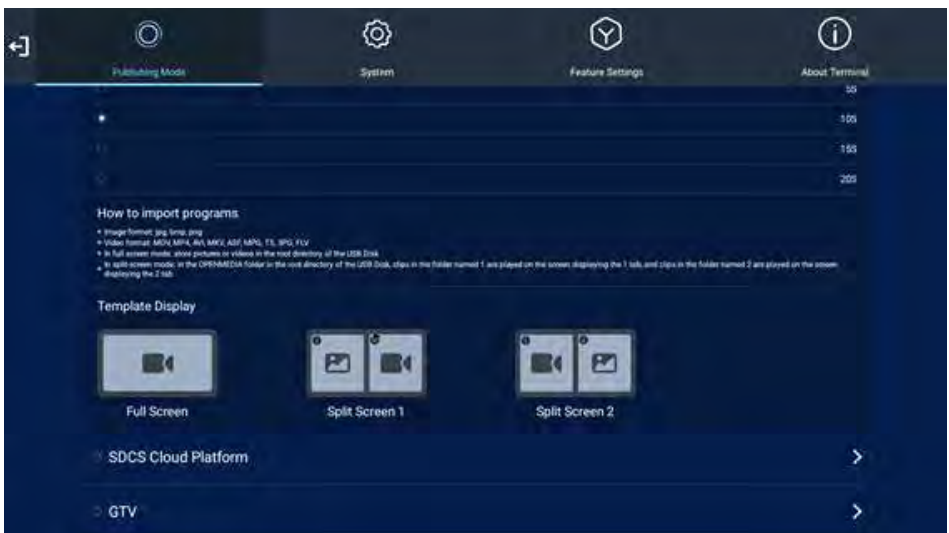
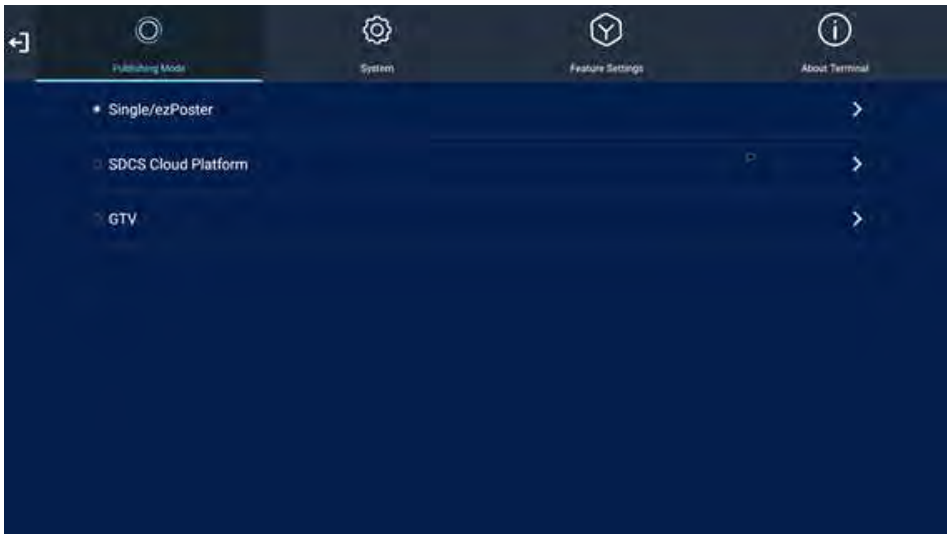

4.1.2. SDCS Cloud Platform

To publish programs through the SDCS cloud platform, you need to first register and log in to the cloud platform for free using a mobile or computer browser. Scan the QR code "Scan Binding Terminal" on the stop interface to bind the terminal.

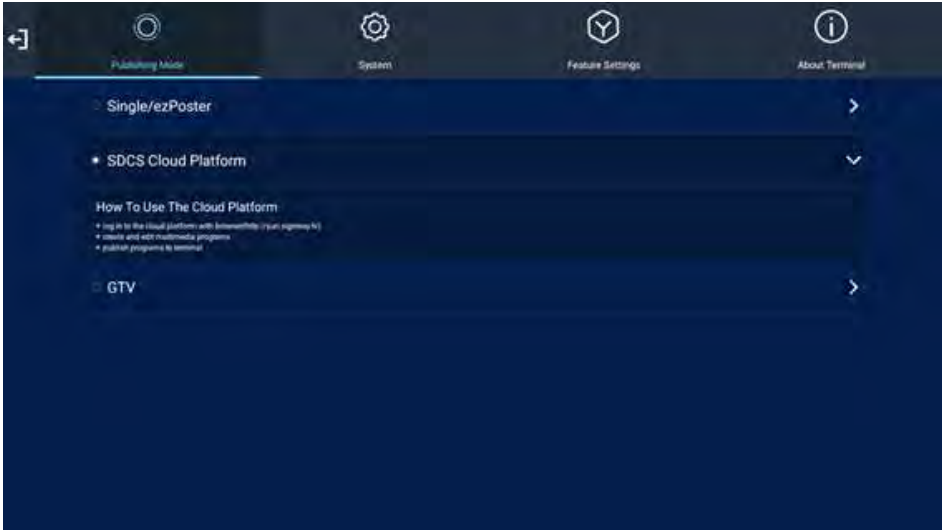

4.1.3. GTV

To publish programs through the GTV platform, it is necessary to set up a domain name/IP address and port.

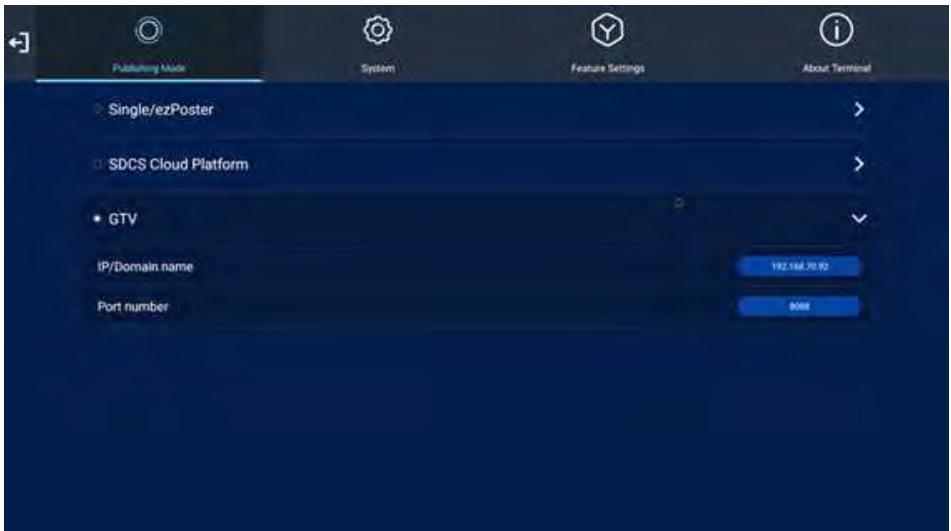

4.2. System

The system settings module provides settings such as screen rotation, display language, date, and time.

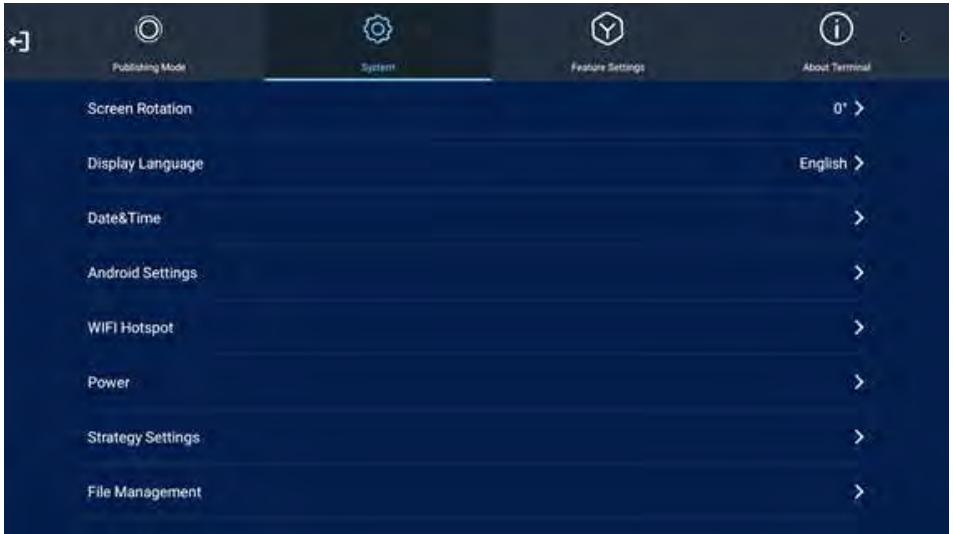

4.2.1. Screen Rotation

The selected screen display direction must be consistent with the actual display mode.

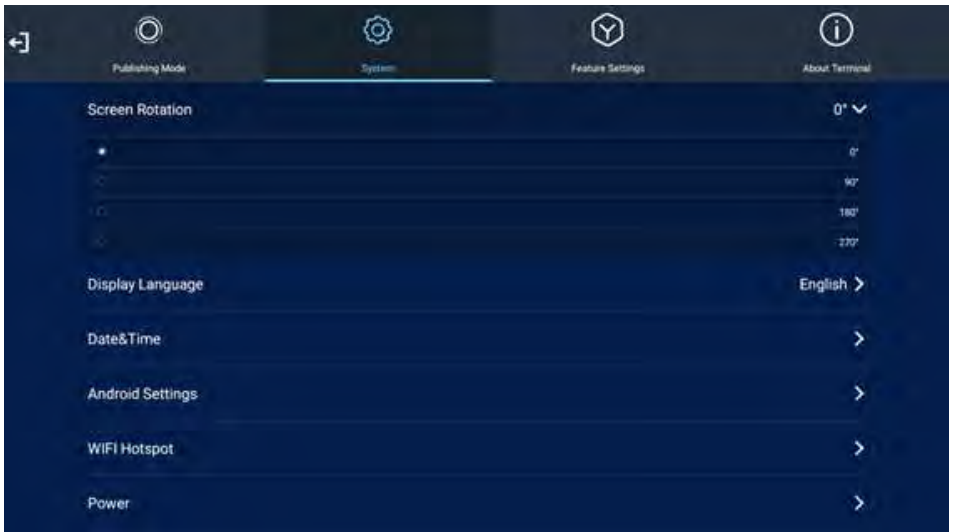

4.2.2. Display Language

Select system language mode, support: Simplified Chinese and English.

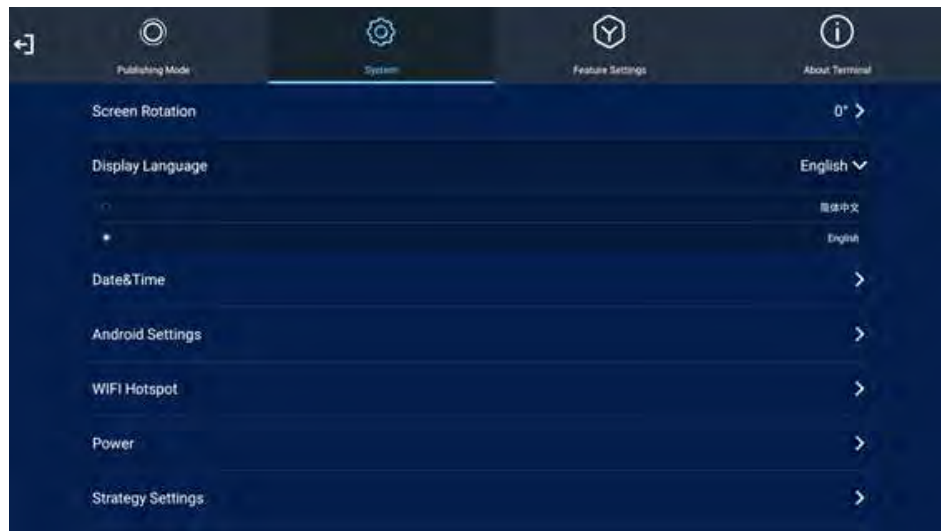

4.2.3. Date&Time

This module can set the system date and time. Note: When the terminal operates in standalone mode, there is no synchronization function available here.

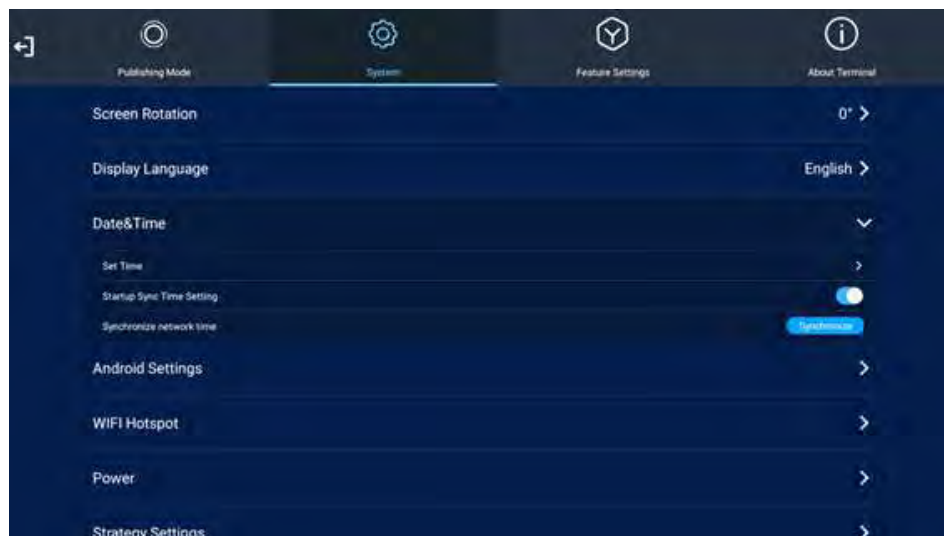

4.2.3.1. Set Time

Date: Select Date to enter the time setting interface. Press the "+/-" button to adjust the date. After the adjustment is complete, press Yes to save.



Time: Select the time display box, press the "+/-" button to adjust the time, and after the adjustment is complete, press Yes to save.

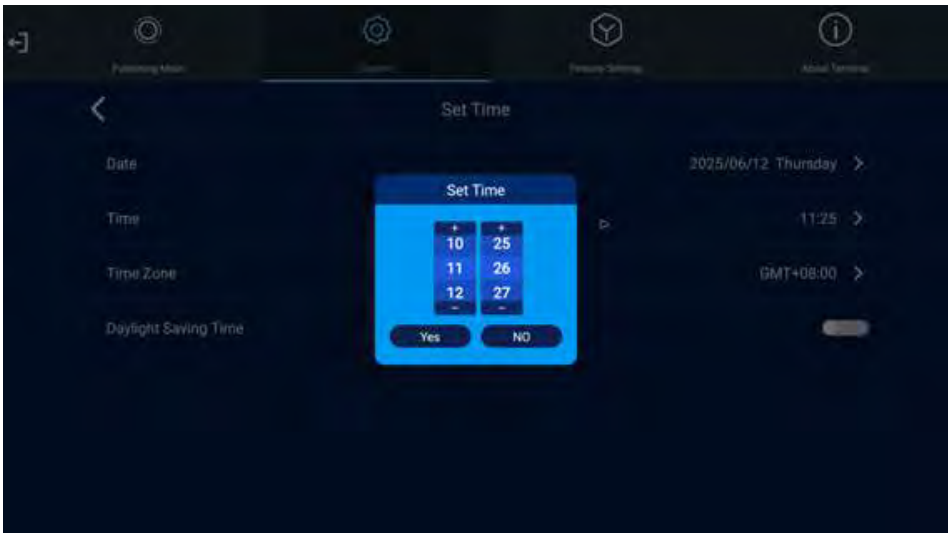

Time Zone: Select the time zone where the terminal is located.

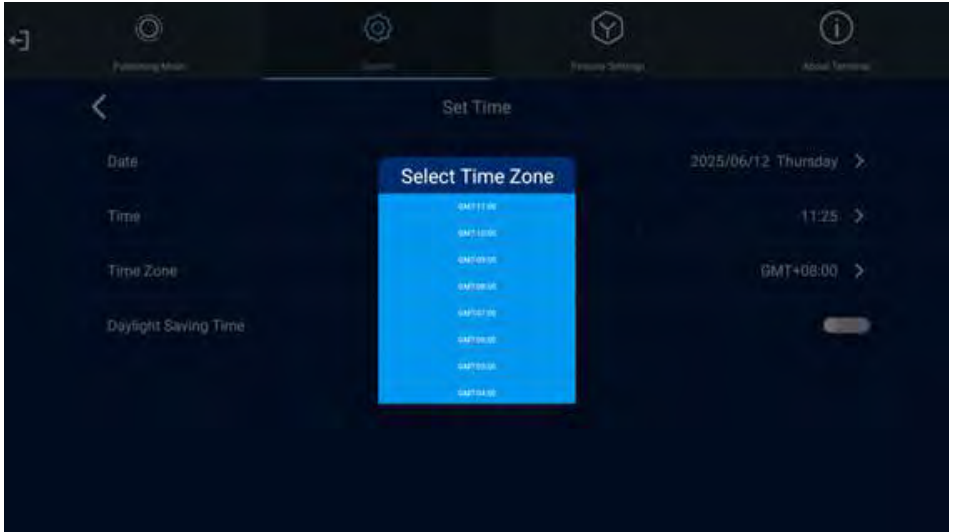

Daylight Saving Time: Choose whether to turn on the daylight saving time switch.

4.2.3.2. Startup Sync Time Setting

After this function is enabled, the system performs network time synchronization when booting up, automatically synchronizing the server time to the terminal; Otherwise, the network time will not be synchronized during startup.

4.2.3.3. Synchronize network time

Click on Synchronize, and the system will start synchronizing network time. After successful synchronization, provide a prompt. At this point, the server time is synchronized to the terminal, and the terminal displays the same time as the server.

Note: Before synchronizing network time, please select the correct time zone.

4.2.4. Android Settings

This system supports Android settings function, which can redirect to the Android interface to set wireless network, notifications, displays, wallpapers, and other content. Right clicking on the Android interface will take you back to the previous step.

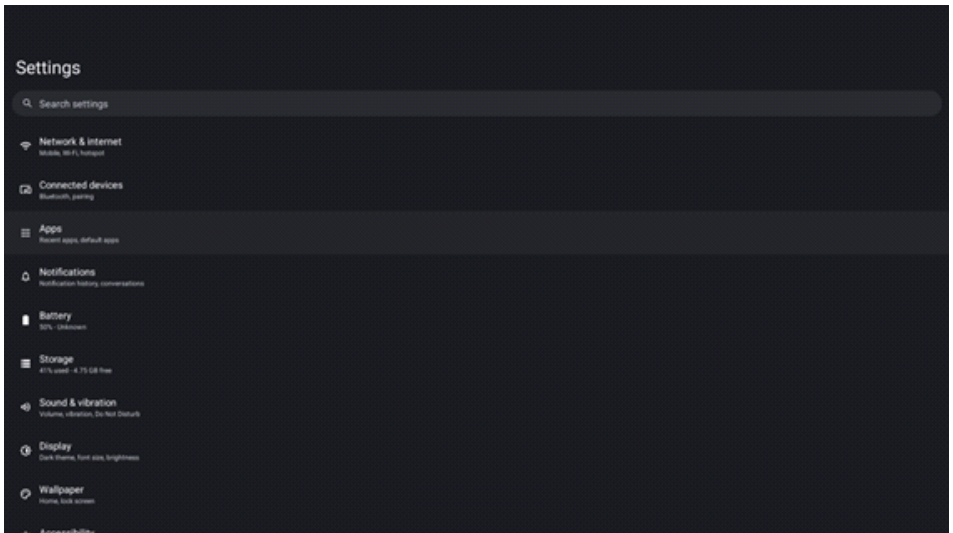
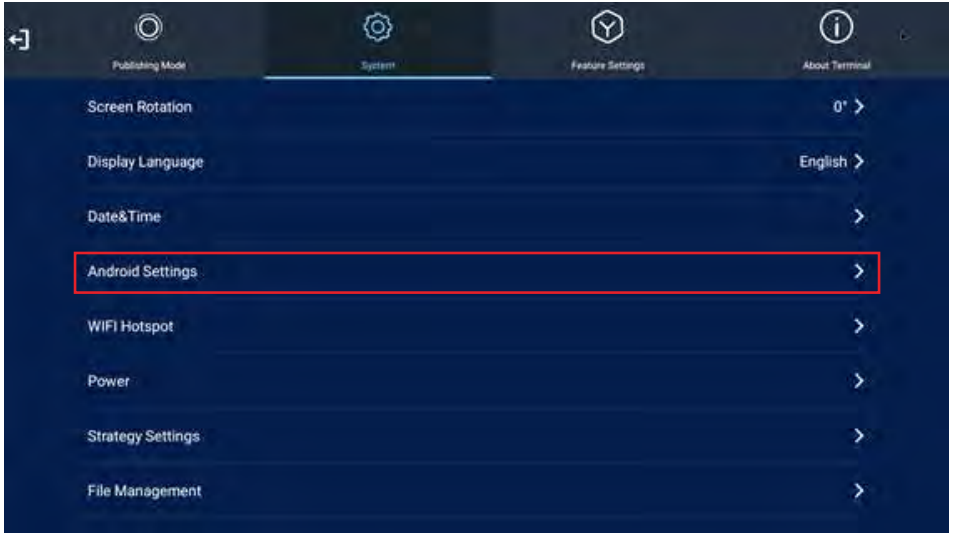

4.2.5. WIFI Hotspot

This system supports setting up WIFI hotspots. Select WIFI hotspot on the right interface to set it up, right-click to save and return to the previous step.

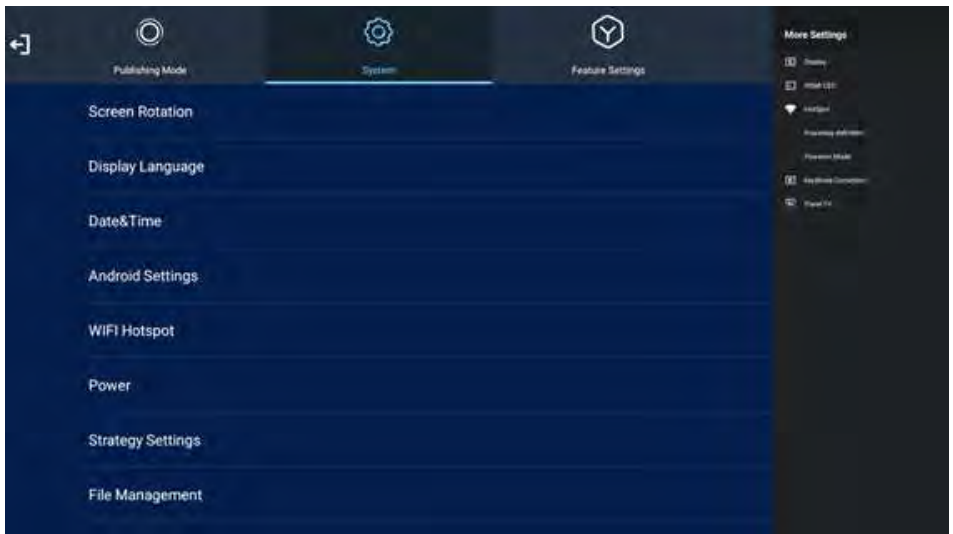

4.2.6. Power

It supports the setting of timing on/off, and supports two modes: daily mode and weekly mode.

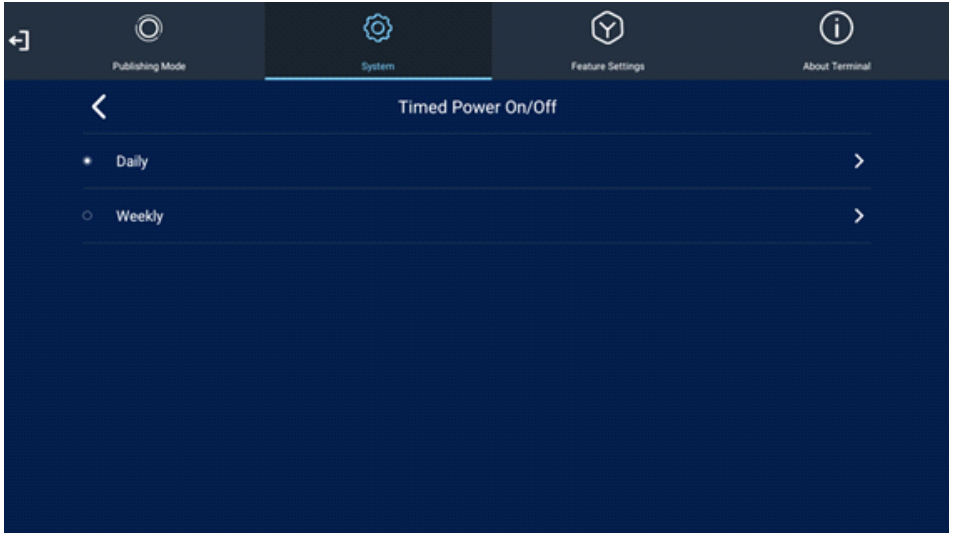

4.2.6.1. Daily

After setting, the system will turn on or off at the designated time every day. For example, it can be set to turn on at 8:00 am and turn off at 22:00 pm every day.

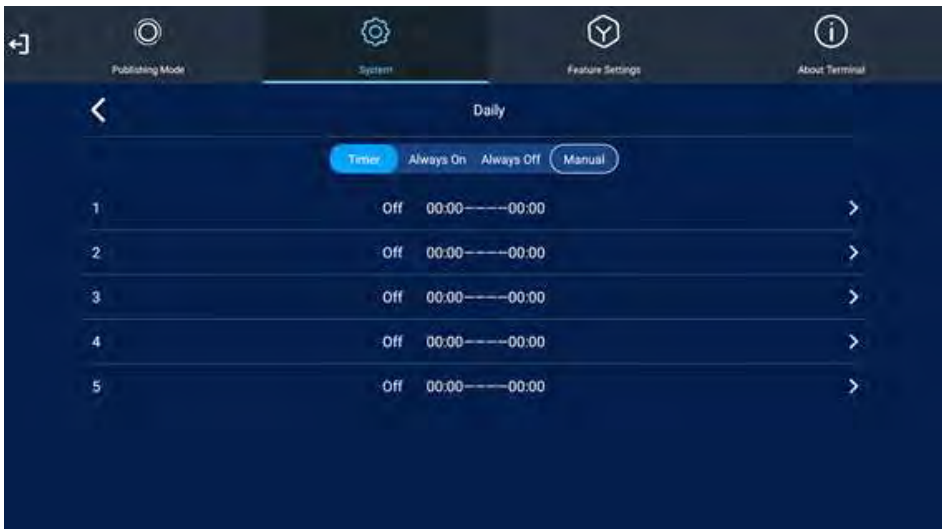

Timer: Power on or off at a specified time point. After selection, 5 sets of power on/off times will be displayed below, each of which can be individually set with a power on time point, a power off time point, and whether to "turn on" or "turn off".

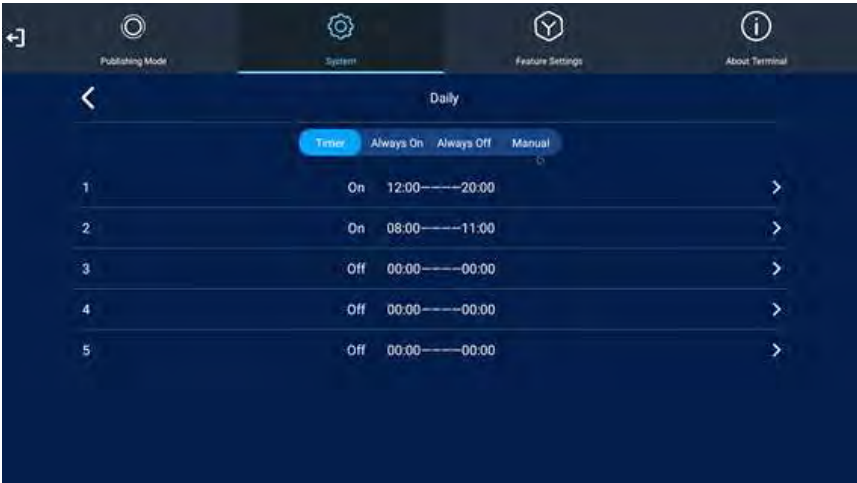
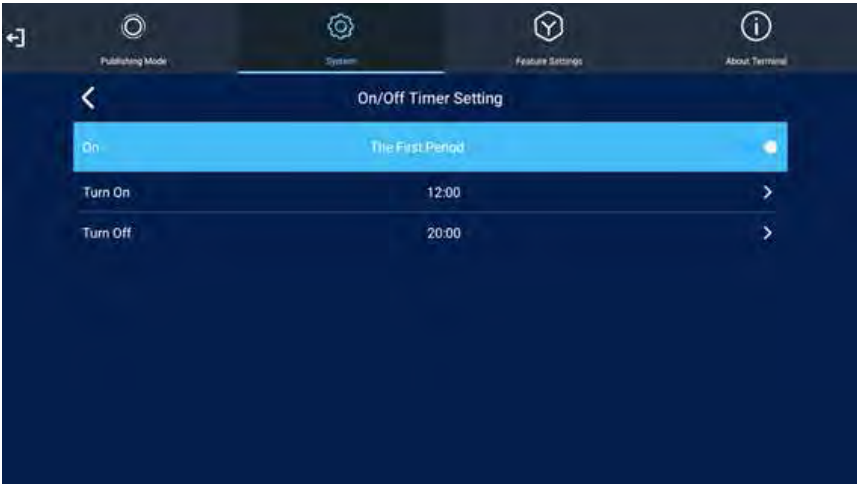

Always On: The terminal remains powered on and never automatically shuts down when connected to a power source.

Always Off: The terminal remains in a shutdown state and never automatically turns on. After selecting this mode and exiting the menu, the terminal will automatically shut down and remain in a shutdown state after 2 minutes of inactivity.

Manual: Users use the remote control to manually control the on/off time of the terminal.

4.2.6.2. Weekly

After setting, the system will be turned on or off at the designated time every Monday, Tuesday... Sunday. For example, it can be set to turn on at 8:00 am and turn off at 22:00 pm every Monday. Power on every Tuesday at 9:00 am and turn off at 23:00 pm.

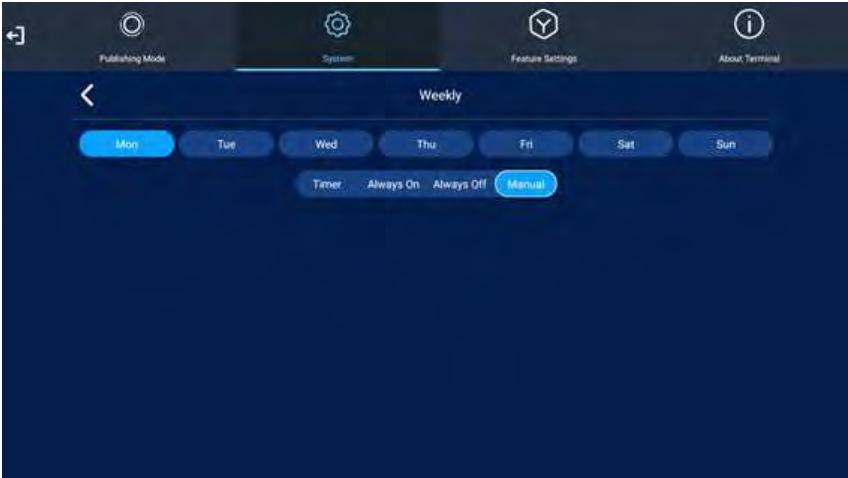

Taking setting the power on/off time on Mondays as an example, select the "Monday" option, and then choose the power on/off mode. The descriptions of each mode are as follows:

Timer: Power on or off at a specified time point. After selection, 5 sets of power on/off times will be displayed below, each of which can be individually set with a power on time point, a power off time point, and whether to "turn on" or "turn off".

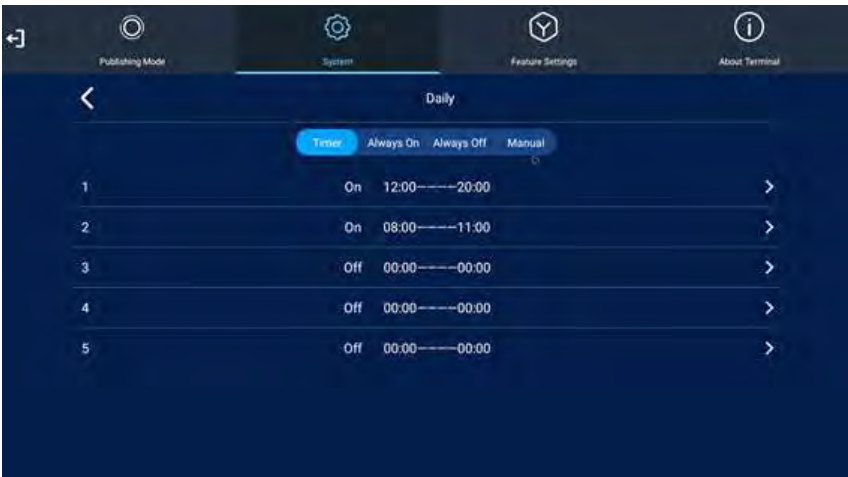

Always On: The terminal remains powered on and never automatically shuts down when connected to a power source.

Always Off: The terminal remains in a shutdown state and never automatically turns on. After selecting this mode and exiting the menu, the terminal will automatically shut down and remain in a shutdown state after 2 minutes of inactivity.

Manual: Users use the remote control to manually control the on/off time of the terminal.

4.2.7. Strategy

The system supports volume and port policy settings.

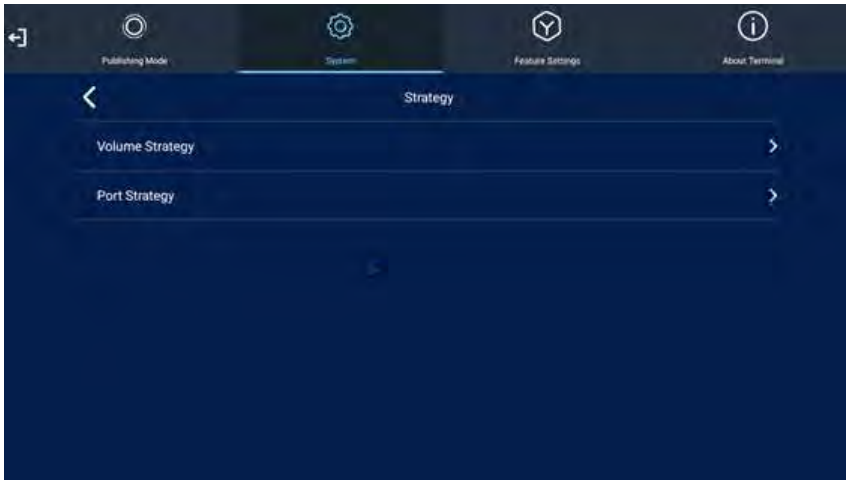

4.2.7.1. Volume Strategy

Used to set the playback volume of the terminal in different time periods.

- When the volume strategy is turned off, you can manually adjust the terminal volume.

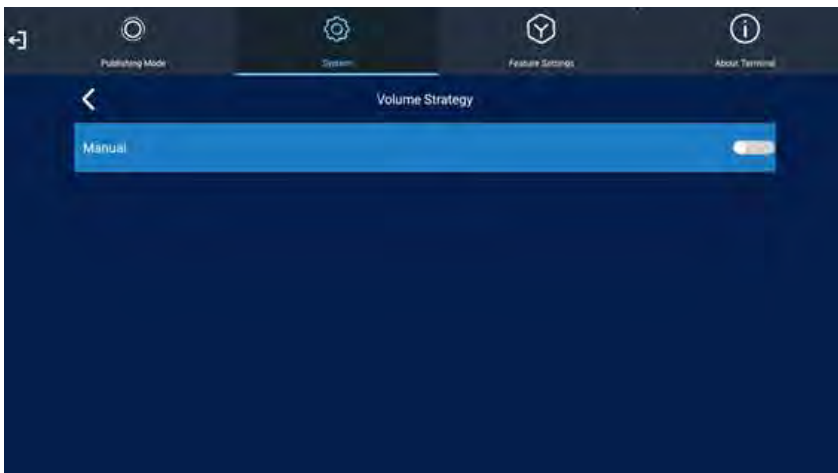

- After the volume strategy is enabled, the volume can be set for up to 5 different time periods. First, open the time period, then set the volume, as well as the start and end times of the volume application.



4.2.7.2. Port Strategy (This feature is only applicable to devices that support HDMI-IN).

Used to set the input source for the terminal in different time periods.

- When the port policy is turned off, you can manually adjust the port policy.
- After the port policy is enabled, ports can be set for up to 5 different time periods. First, open the time period, then set the port, as well as the start and end times of the volume application.



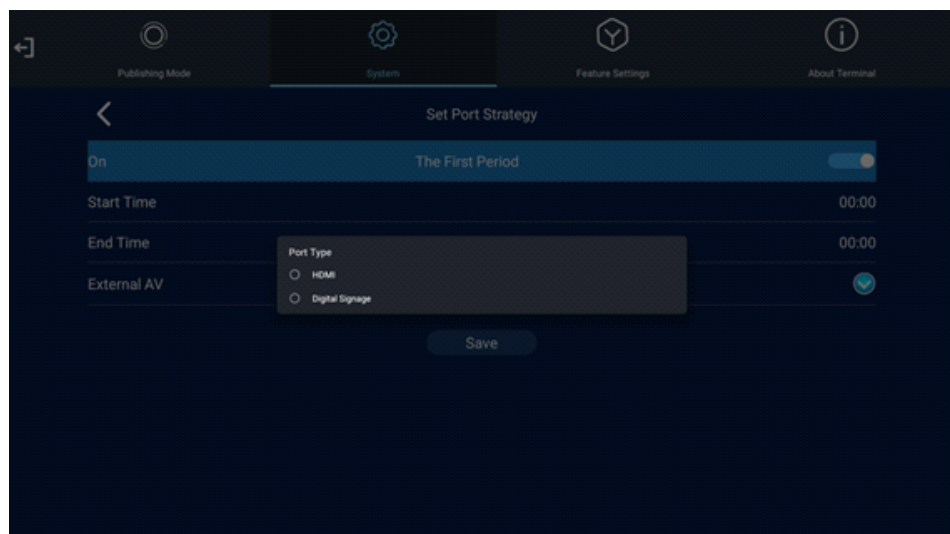
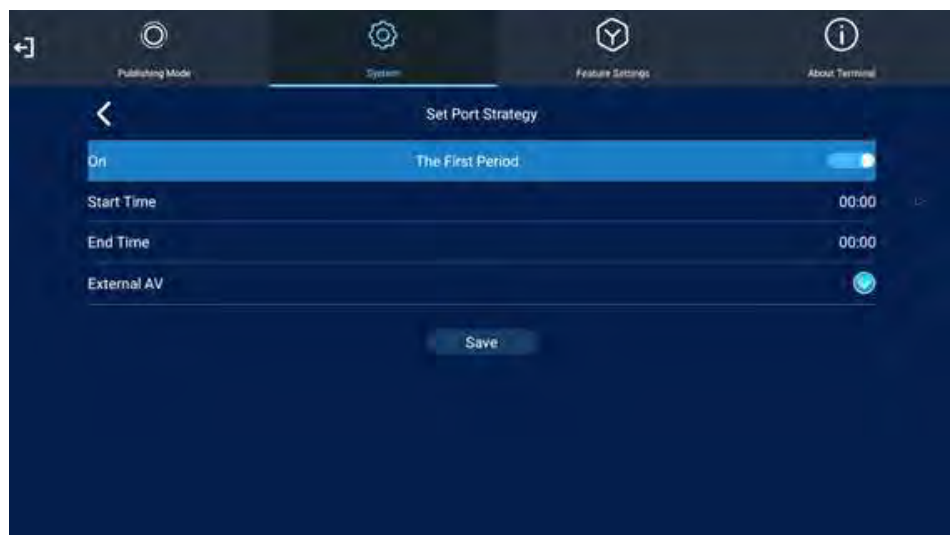

4.2.8. File Management

The built-in storage usage information can be viewed in the file management menu, and the disk can be formatted.

Select 'Format' and press the confirm button to format the built-in memory.

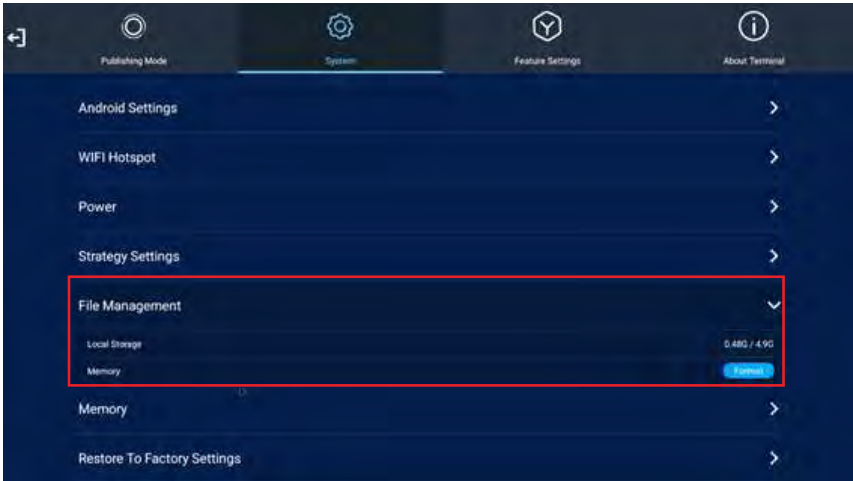

4.2.9. Memory

The available memory options vary in different working modes.

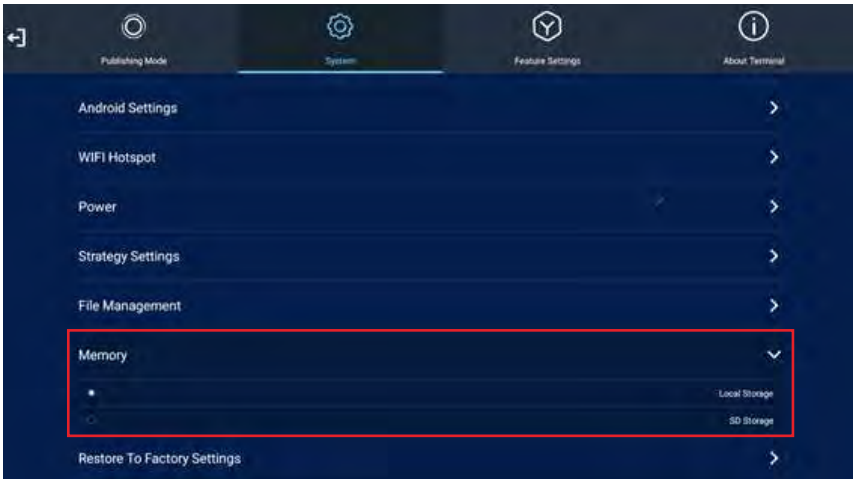

Local Storage: Programs downloaded from the server are stored in the built-in memory and used for playback.

SD Storage: Programs downloaded from the server are stored in SD and used for playback.

4.2.10. Restore To Factory Settings

Select 'Restore Factory Settings', and the following prompt will appear on the interface. Click Yes, and all system settings parameters will be restored to their factory settings; If you choose No, there will be no change.

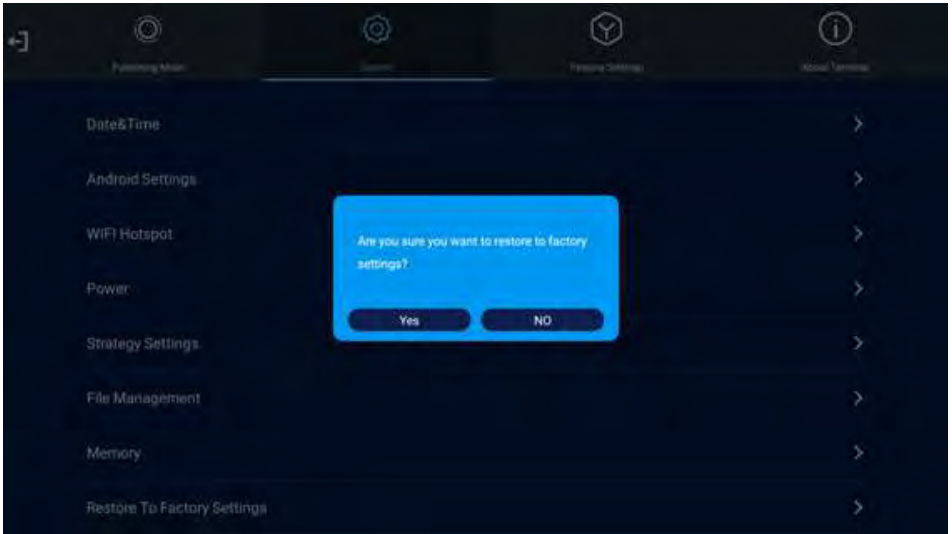

4.3. Feature Settings3.3.1. Real Time Clock



4.3.1. Real Time Clock

The terminal interface can display the current time, and the display position of the real-time clock can be set here.



Top Left/Bottom Left/top Right/Bottom Right: Display the real-time clock in the top left, bottom left, top right, or bottom right corner of the screen.

Close: The terminal screen does not display the real-time clock.

4.3.2. Password Lock

The system supports changing password lock passwords.

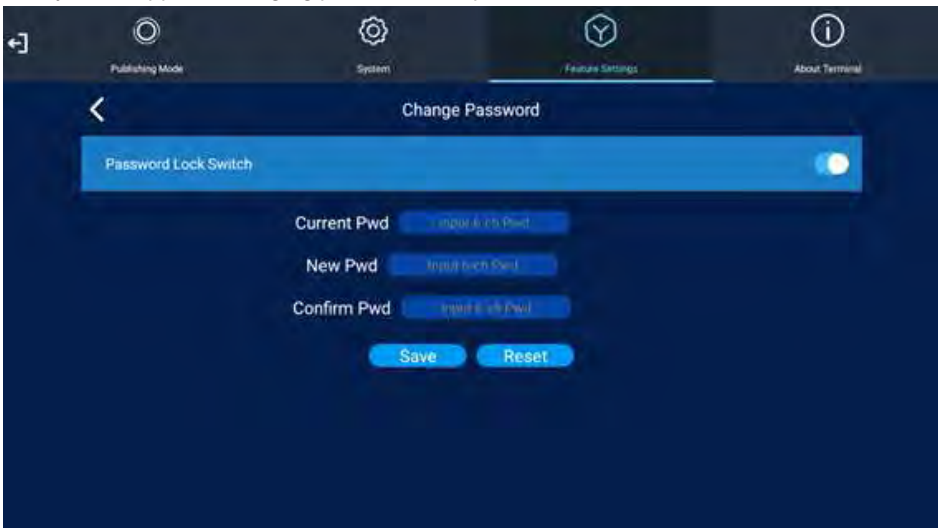

4.3.3. Sync Setting

The terminal supports synchronization function, and multiple terminals can play programs synchronously. The synchronization function can be set here.

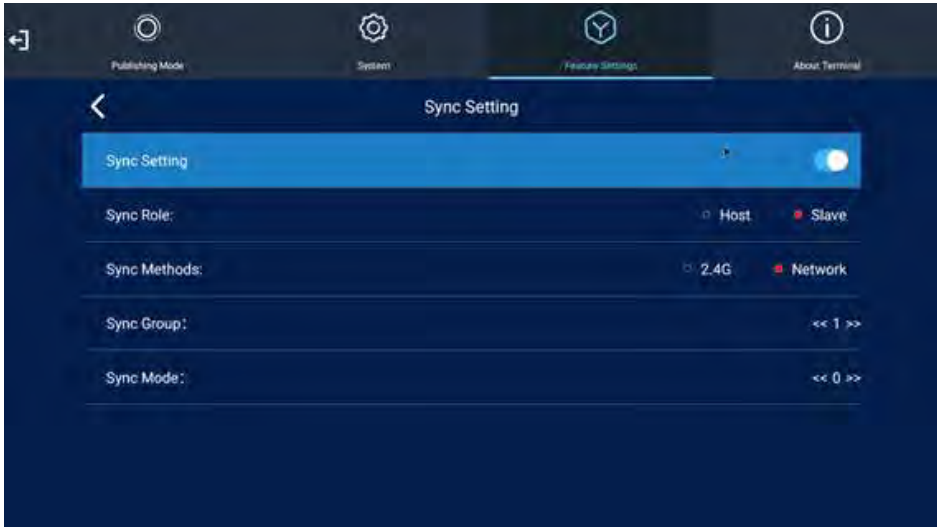

Sync Setting: Turn on or off the synchronization function.

Sync Role: Host: When using the synchronization function, set the current terminal as the host, and other slaves will play the same or different programs simultaneously with the host. Only one host can exist in the same area.

Slave: Automatically synchronize with the host to play programs.

Sync Methods: Use 2.4G network or wireless network.

Sync Group: can be set to 0~255.

Sync Mode: 0: The host sends a synchronization signal at the beginning of playing each material.

1: The host sends a synchronization signal every minute.

(The host sends a synchronization signal, which is only sent at the beginning of the video playback and will not be sent during the video playback)

In the test mode of '0' mode, the slave will have an arrow synchronization flag in the upper left corner after receiving the synchronization signal.

4.3.4. WebView Setting

Choose whether to turn on the user agent and hardware acceleration switch.

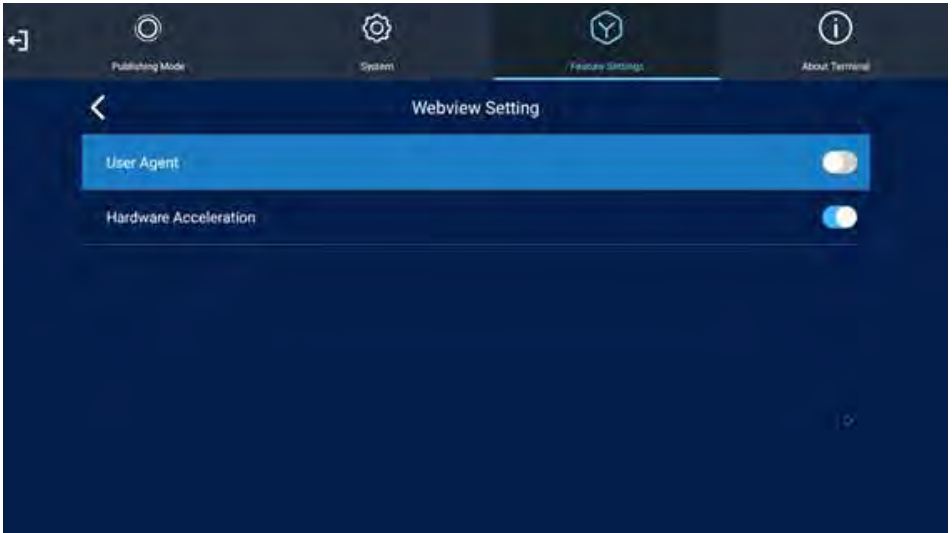

4.3.5. Standby

Choose whether to turn on the 'Deep Standby' switch.

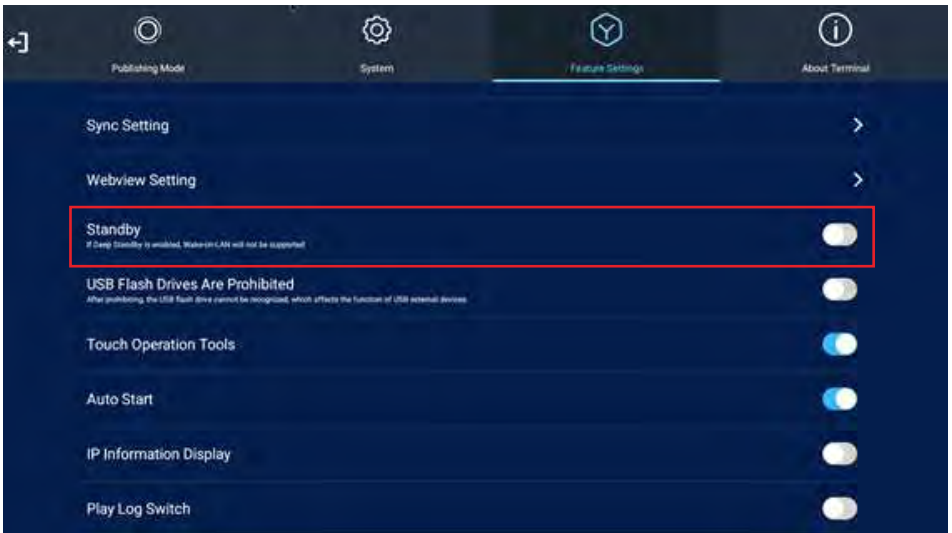

4.3.6. USB Flash Drives Are Prohibited

Choose whether to turn on the 'disable USB drive' switch.

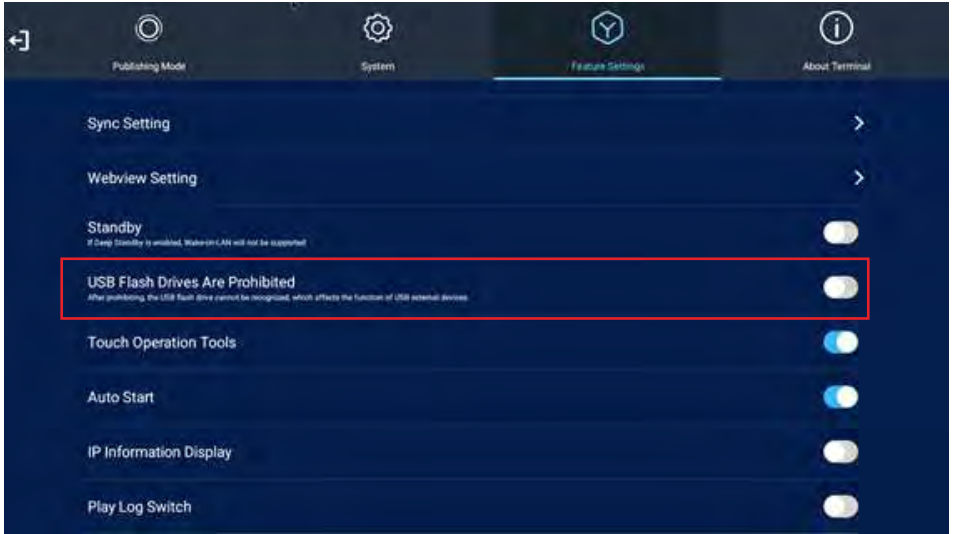

4.3.7. Touch Operation Tools

Here, you can set whether the terminal screen touch assist tool is displayed.

Off: The screen does not display the auxiliary touch tool. To access the tool, tap twice in the upper left corner and tap twice in the lower left corner of the screen.

On: Touch assist tool is displayed in the upper left corner of the screen.

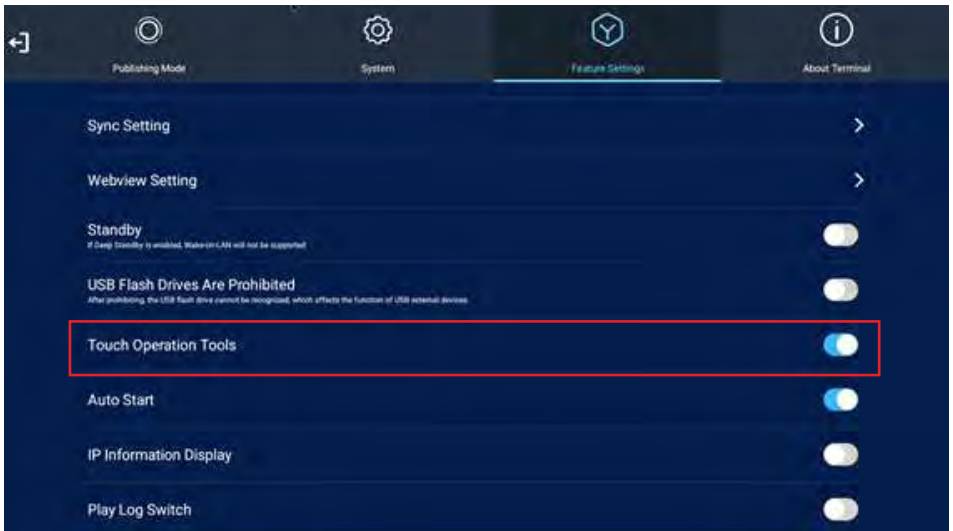

4.3.8. Auto Start

Here, you can set whether to turn on the startup auto start function.

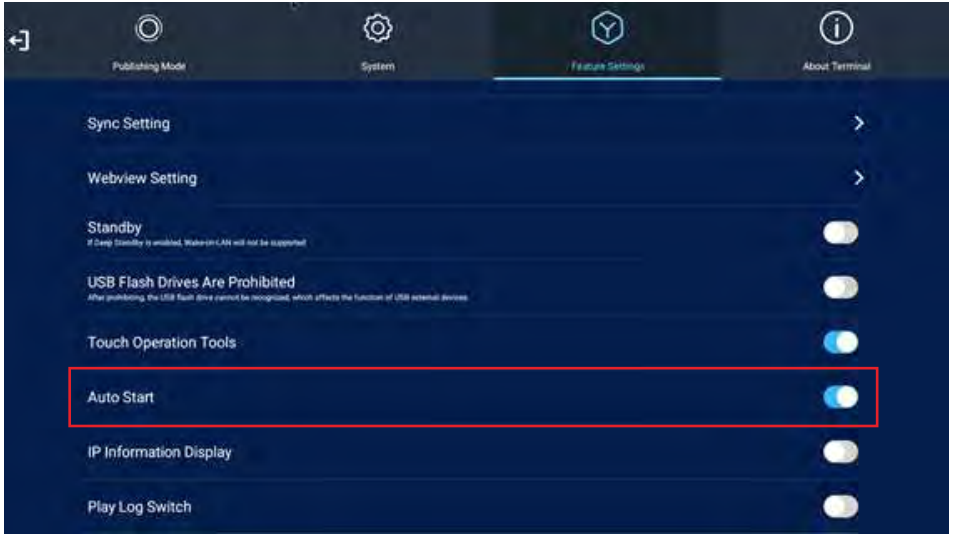

4.3.9. IP Information Display

On - Display IP information on the main interface;

Off - The main interface does not display IP information.

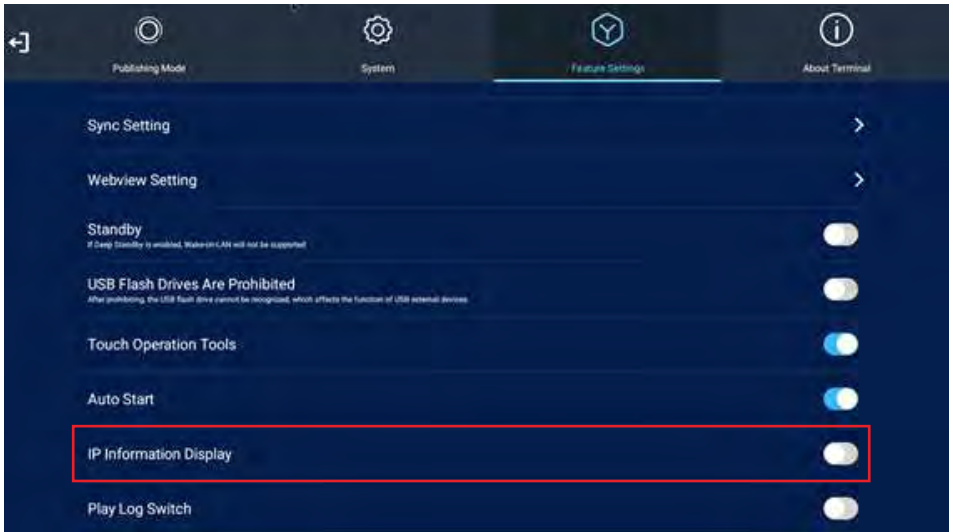

4.3.10. Play Log Switch

Set whether to enable the playback log function. After activation, the terminal system will record the program playback status and upload it to the server platform.

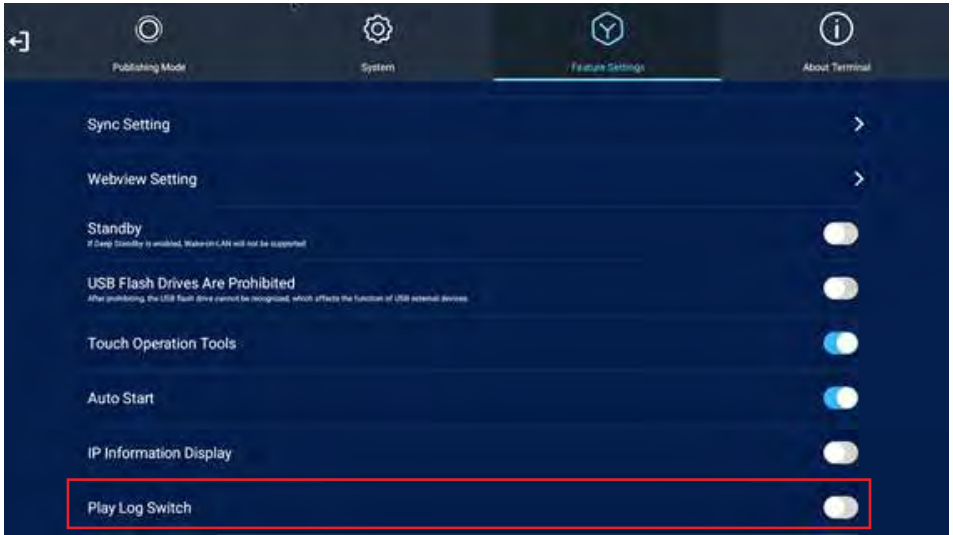

4.4. About Terminal

Used to display resolution, local ID, local name, TCP port, UDP port, and MAC address.



Support modifying the local machine number.



5. System Upgrade

The player system can be upgraded via a USB disk on site.

USB Drive Upgrade

You can also use USB storage devices for system upgrades, as follows.

1. Enter the OSD menu, select System Settings>Disable USB flash drive, and ensure that the USB interface is turned on.



After activation, the button on the right displays blue, as shown in the above figure.

2. Save the upgrade file android_update.zip to the root directory of a USB disk.
3. Plug the USB disk into the player's USB port with the player turned on.

NOTE: Do not plug in the USB disk during content downloading.

4. Once the USB disk is detected, system will check the files in it.
5. During file checking, the upgrade file version will be compared with the current one and the result will be given to you like below, allowing you to choose whether to continue.
6. When copying completed, you'll be prompted with the following message.
7. When copying completed, you'll be prompted with the following message.

NOTE: Avoid power outage during system upgrade. Otherwise, the system may be destroyed and cannot run or upgrade anymore.

6. Product Warranty and Maintenance

6.1 Warranty Policy

- A one-year warranty is provided starting from the purchase date, covering normal and reasonable use of the device.
- Unauthorized modifications or parts replacements will void the warranty.

6.2 Maintenance Guidelines

1. Regularly clean the device, including dusting the surface and frame.
2. Follow the safety precautions listed in Section 1.5.
3. In case of device failure, inform the seller and ensure that any maintenance works or repairs be performed by a qualified professional.